

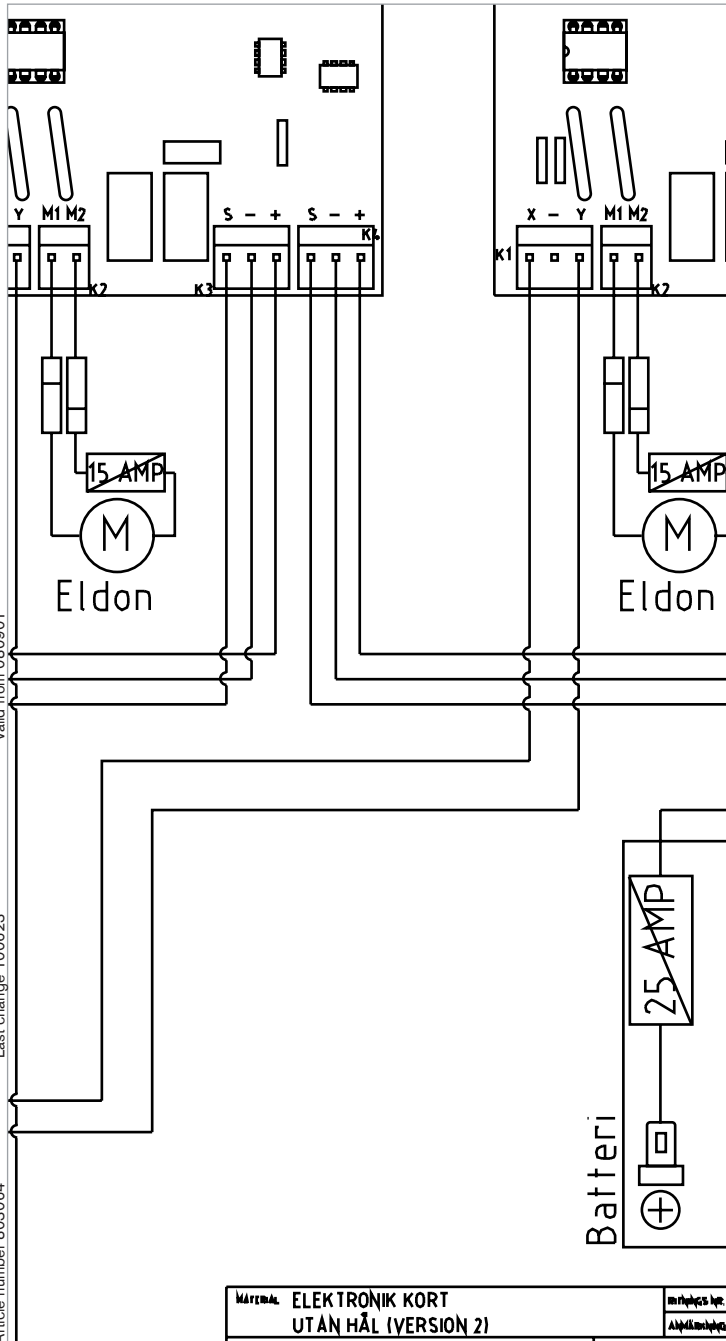

# REAL ELECTRONICS

REAL 9000 Version 2



UP/DOWN

Article nr. 802546

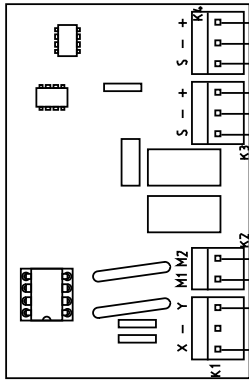

SEAT ANGLE

Article nr. 802578

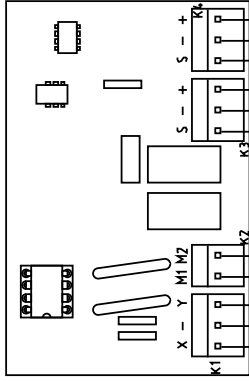

BRAKE

Article nr. 802600

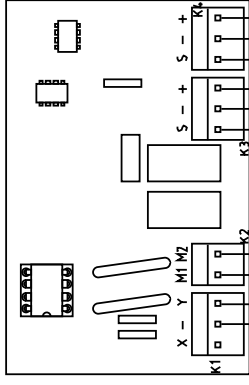

BACK ANGLE

Article nr. 802578

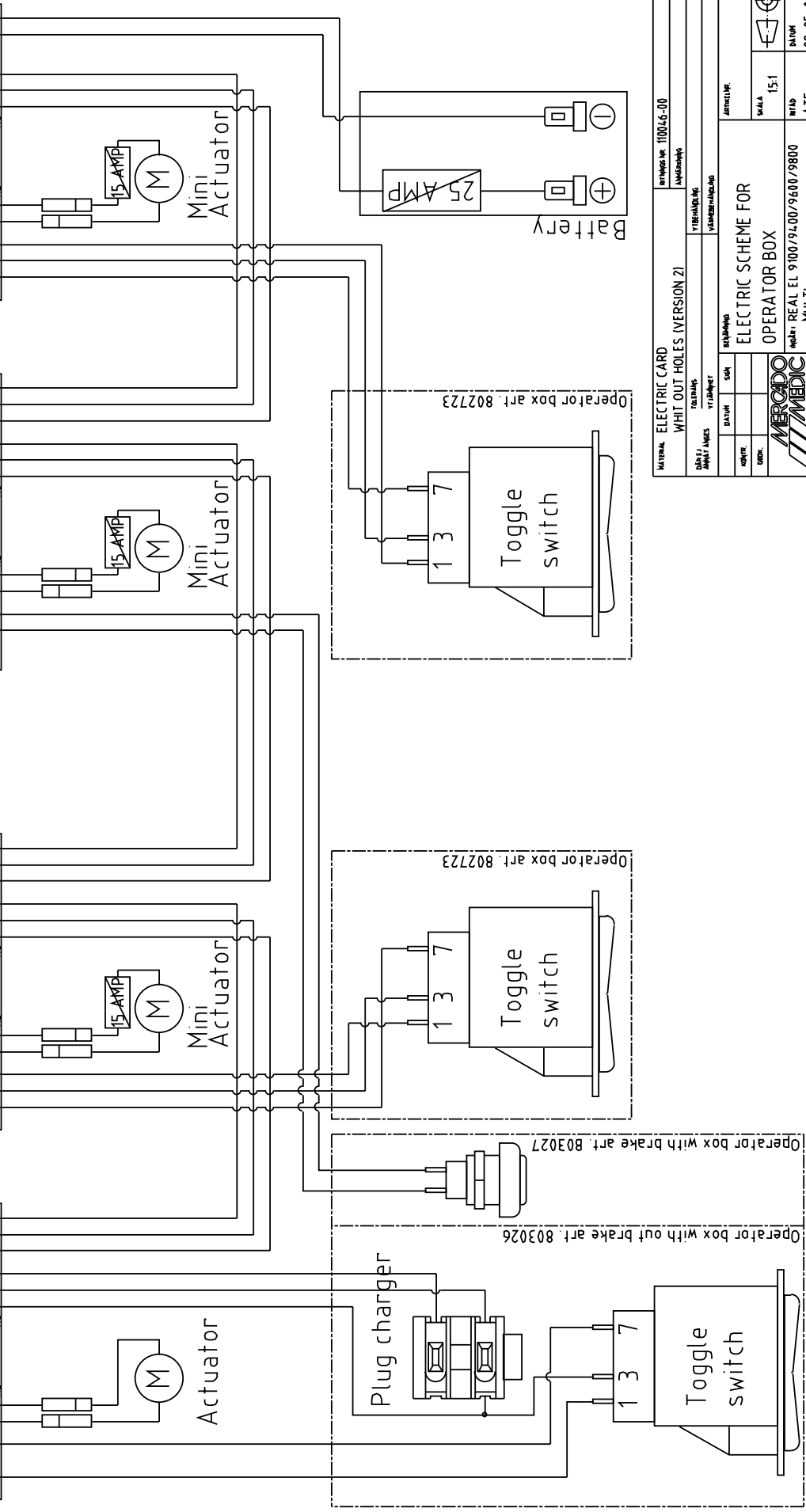
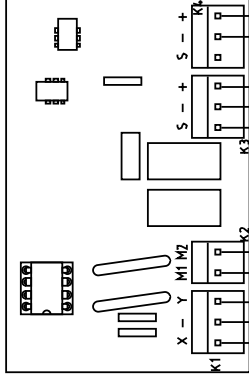

MATERIAL		ELECTRIC CARD		SERIES NR. 110046-00	
WHIT OUT HOLES (VERSION 2)		VIBRABLOK		A4646464	
REVISIONS	TRADINGS	REVISIONS	TRADINGS		
DATE / J. / ANNEE	DATE / J. / ANNEE	DATE / J. / ANNEE	DATE / J. / ANNEE		
DESIGNER	DATE / J. / ANNEE	DESIGNER	DATE / J. / ANNEE		
DATE / J. / ANNEE	DATE / J. / ANNEE	DATE / J. / ANNEE	DATE / J. / ANNEE		
ELECTRIC SCHEME FOR		ELECTRIC SCHEME FOR			
OPERATOR BOX		OPERATOR BOX			
MATER. REAL EL 9100/91400/9600/9800		MATER. REAL EL 9100/91400/9600/9800			
MOL TI		MOL TI			
MERCADO MEDIC		MERCADO MEDIC			
SCALE		SCALE		15:1	
DATE		DATE		28-05-08	

UP/DOWN

Article nr. 802546

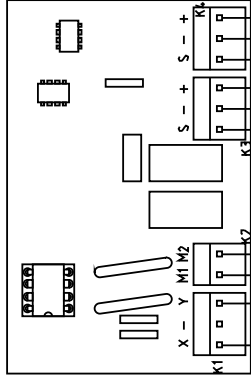

SEAT ANGLE

Article nr. 802578

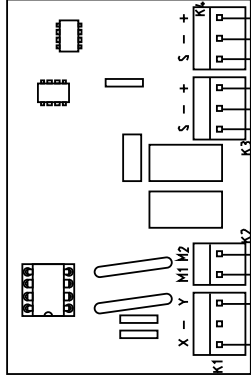

BREAK

Article nr. 802600

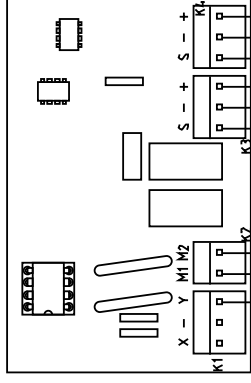

BACK ANGLE

Article nr. 802578

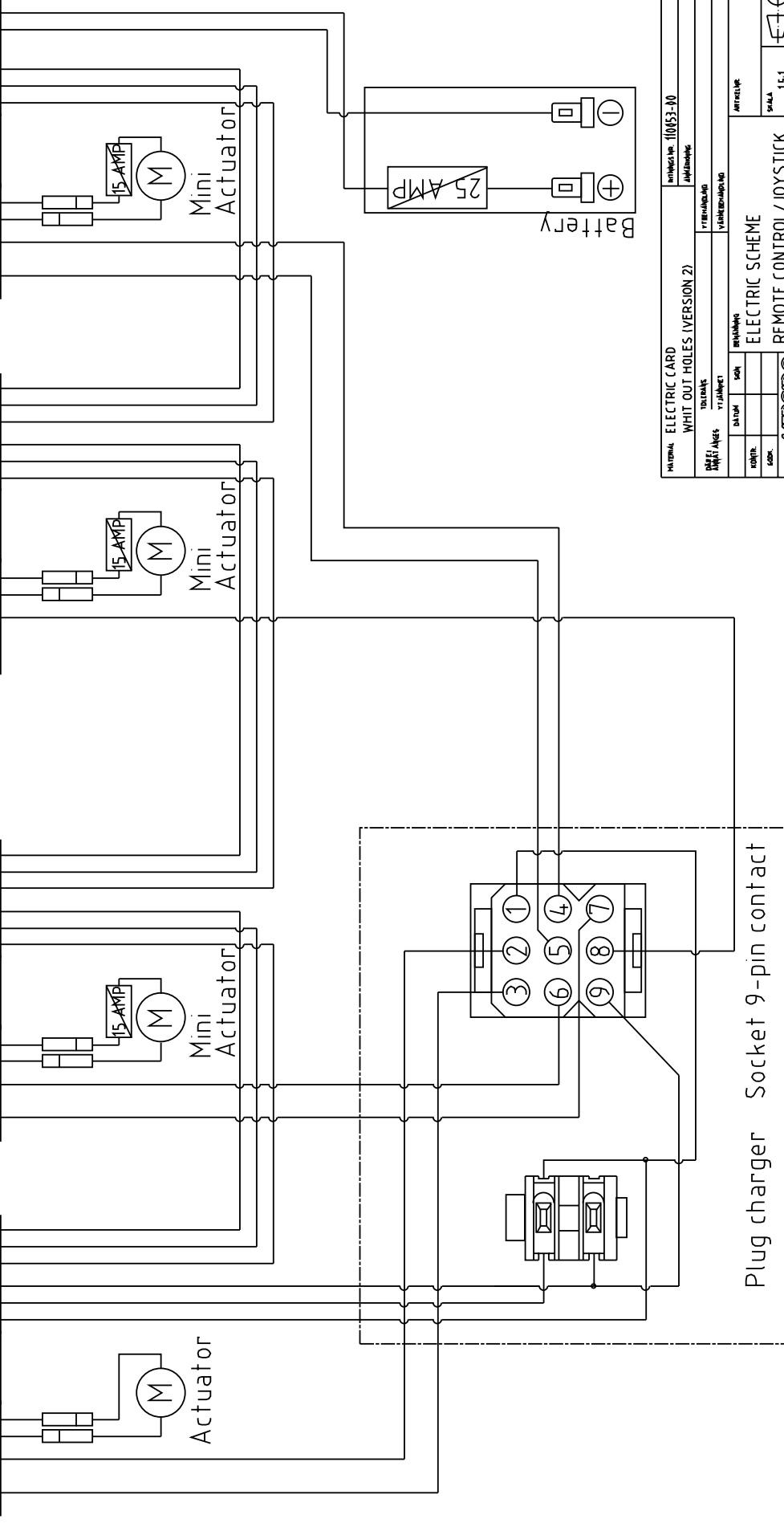
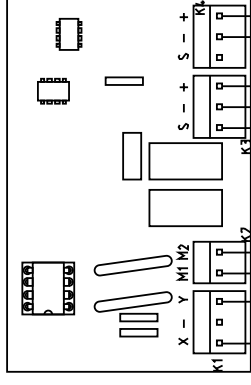

Plug charger Socket 9-pin contact

Charge box multi art. 803030 multi functions

INTERNAL ELECTRIC CARD		REVISIONE 10/05/00	
WHIT OUT HOLES (VERSION 2)		APPLICAZIONE	
PROJEZIONE		VERBALE/PROJEZIONE	
SCALE		ATTREZZE	
ELECTRIC SCHEME		SCALE 1:5:1	
REMOTE CONTROL / JOYSTICK		M/T/D	
MERCIDO REAL ELECTRIC		ATE	
9100/914.00/9600/9800 MUL.TI		13-08-08	

# NEW ELECTRONICS FOR UP & DOWN BY MERCADO

Since the new electronics are minuscontrolled they're not backwards compatible. Electronics Version 1 can be combined with the electronics of Version 2.

The image indicates the appliances 802722 & electric lyftomat.

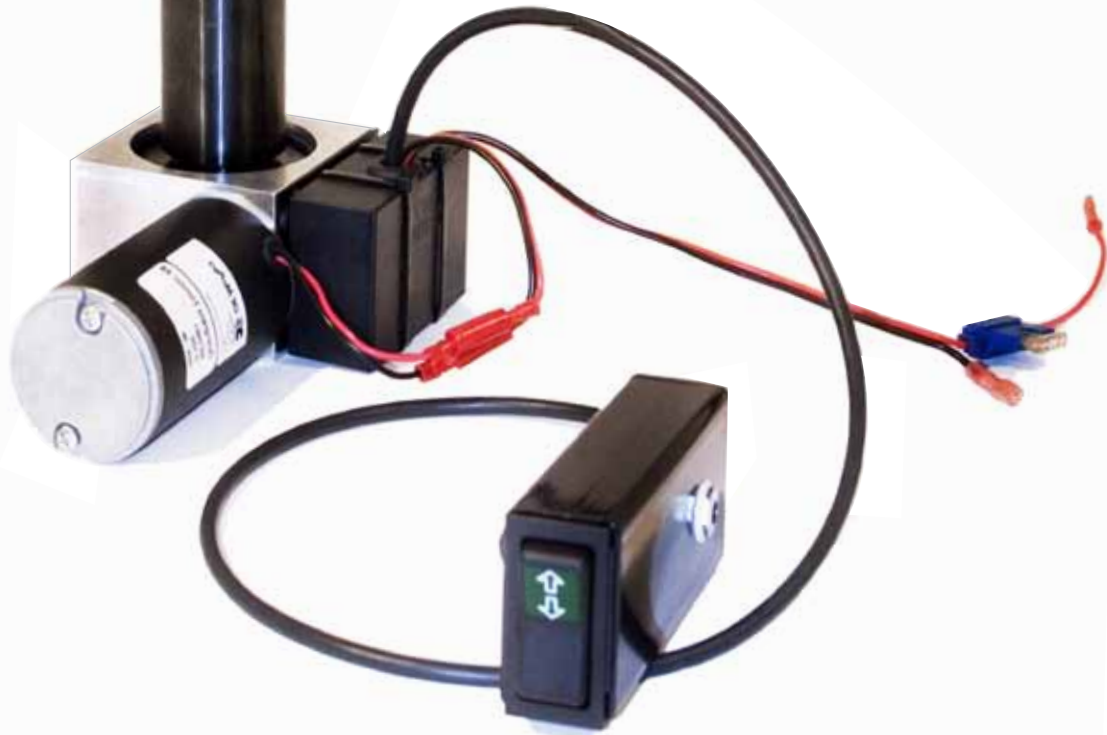

**MOUNTING OF RELAY CARD KIT** **1** Mount the bolster plate with the screws on to the shell of the Liftomat with the arrow pointing upwards towards the pipe of the Liftomat. On the Electric kit the bolster plate shall be mounted on to the back side of the perpendicular plate angle, with the arrow pointing up. **2** Attach the lid over the box with two plastic straps. **3** Shove the box down in the slots of the bolster plate, until the catch fastens.

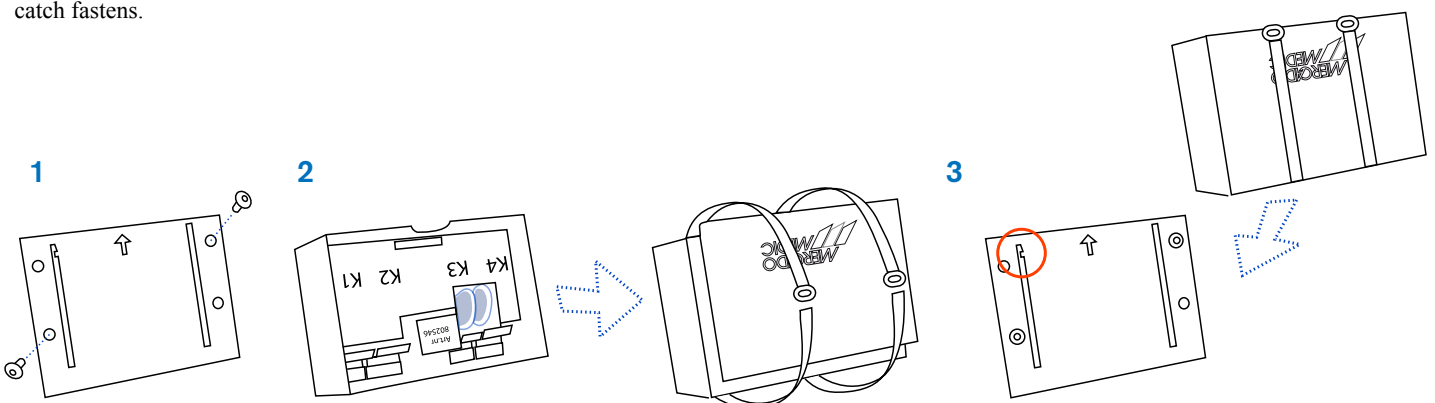

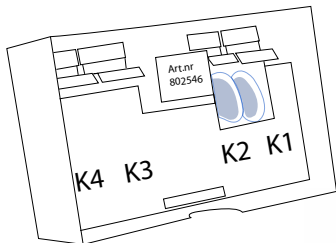

**IF YOU WANT TO BUILD IT YOURSELF, DO LIKE THIS: ON THE CIRCUIT BOARD YOU CAN FIND THE MOLEXCONTACTS K1-K4.**



**WE RECOMMEND YOU TO ORDER THIS KIT WITH ART.NO 802722. IT INCLUDES EVERYTHING.**



**CHARGE BOX UP/DOWN STEP 1**

To connect the [Charge box up/down art.no 803029](#). Engage the contact with **TWO** leaders to the contact on the circuit board marked **K1** and the contact with **THREE** leaders to the contact marked **K3**.

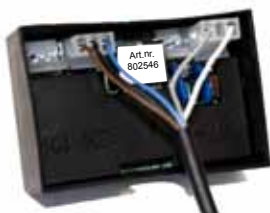

**CHARGE BOX MULTI STEP 1**

To connect the [Charge box multi art.no 803030](#). Use the cord with **TWO** contacts. Engage the contact with **TWO** leaders to the contact on the circuit board marked **K1** and the contact with **THREE** leaders to the contact marked **K3**.



**MANEUVER BOX STEP 1**

To connect the [Maneuver box art.no 802721](#). Engage the contact with **TWO** leaders to the contact on the circuit board marked **K1** and the contact with **THREE** leaders to the contact marked **K3**.



**CHARGE BOX MANEUVER BOX STEP 2**

To connect the [Cabling for Motor art.no 802681](#). Engage the contact to the contact on the circuit board marked **K2**. The other end is to be connected to the engine.



**CHARGE BOX MANEUVER BOX STEP 3**

To connect the [Cabling for Battery art.no 802648](#). Engage the contact to the contact on the circuit board marked **K4**. The other end is to be connected to the battery. **BLACK** cable connects to the negative pole of the battery. **NOTE! RED** cable connects to the positive pole of the battery. (If the chair is a multi, **K4** is used to supply electricity to the next circuit board).

# MERCADOS NEW ELECTRIC KIT & ELECTRONICS FOR SEAT ANGLE

Since the new electronics are minuscontrolled they're not backwards compatible.  
Electronics Version 1 can be combined with the electronics of Version 2.

The image indicates the appliances 802724 and 802730 mounted on to a seatframe that is adjustable in angle.

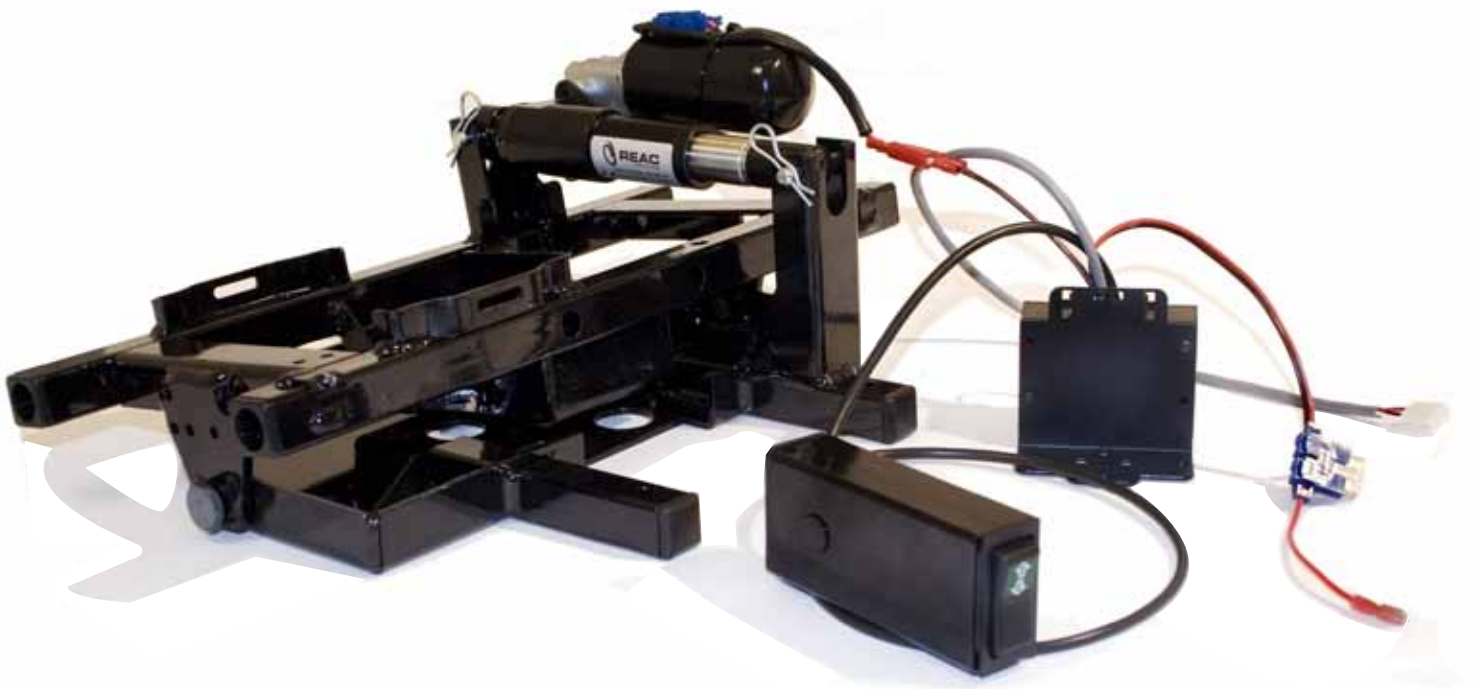

# TO COMPLETE A CHAIR WITH ELECTRIC SEAT ANGLE, WE RECOMMEND YOU TO ORDER THE TWO KITS - **ART.NO 802724 & 802730**

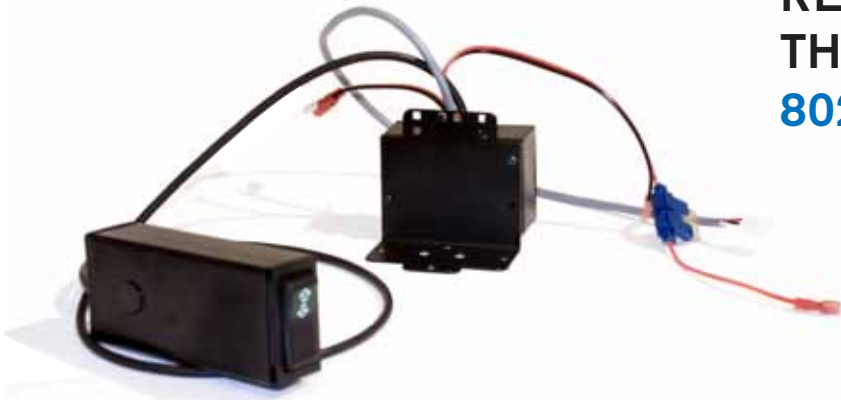

## ◆ CHARGE BOX MULTI STEP 1

To connect the [Charge box multi art.no 803030](#). Engage the contact marked **S** to the contact on the circuit board marked **K1**.



## ◆ MANEUVER BOX STEP 1

To connect the [Maneuver box art.no 802723](#). Engage the contact to the contact on the circuit board marked **K1**.



## ◆ CHARGE BOX ◆ MANEUVER BOX STEP 2

To connect the [Cabling for Motor art.no 802681](#). Engage the contact to the contact on the circuit board marked **K2**. The other end is to be connected to the engine.

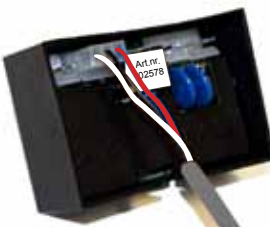

## ◆ CHARGE BOX ◆ MANEUVERBOX STEP 3

To connect the [Cabling for Electricity supply art.no 802718](#). Engage the contact to the contact on the circuit board marked **K3**. NOTE! The cable comes from the circuit board for Up & Down or prior circuit board.



## ◆ CHARGE BOX ◆ MANEUVER BOX STEP 4

To connect the [Cabling for Battery art.no 802648](#). Engage the contact to the contact on the circuit board marked **K4**. The other end is to be connected to the battery. BLACK cable connects to the negative pole of the battery. NOTE! RED cable connects to the positive pole of the battery. (If the chair is a multi, **K4** is used to supply electricity to the next circuit board).

# NEW ELECTRIC KIT & ELECTRONICS FOR BACKREST ANGLE

Since the new electronics are minuscontrolled they're not backwards compatible.

Electronics Version 1 can be combined with the electronics of Version 2.

The image indicates the appliances 802726 & 802731.

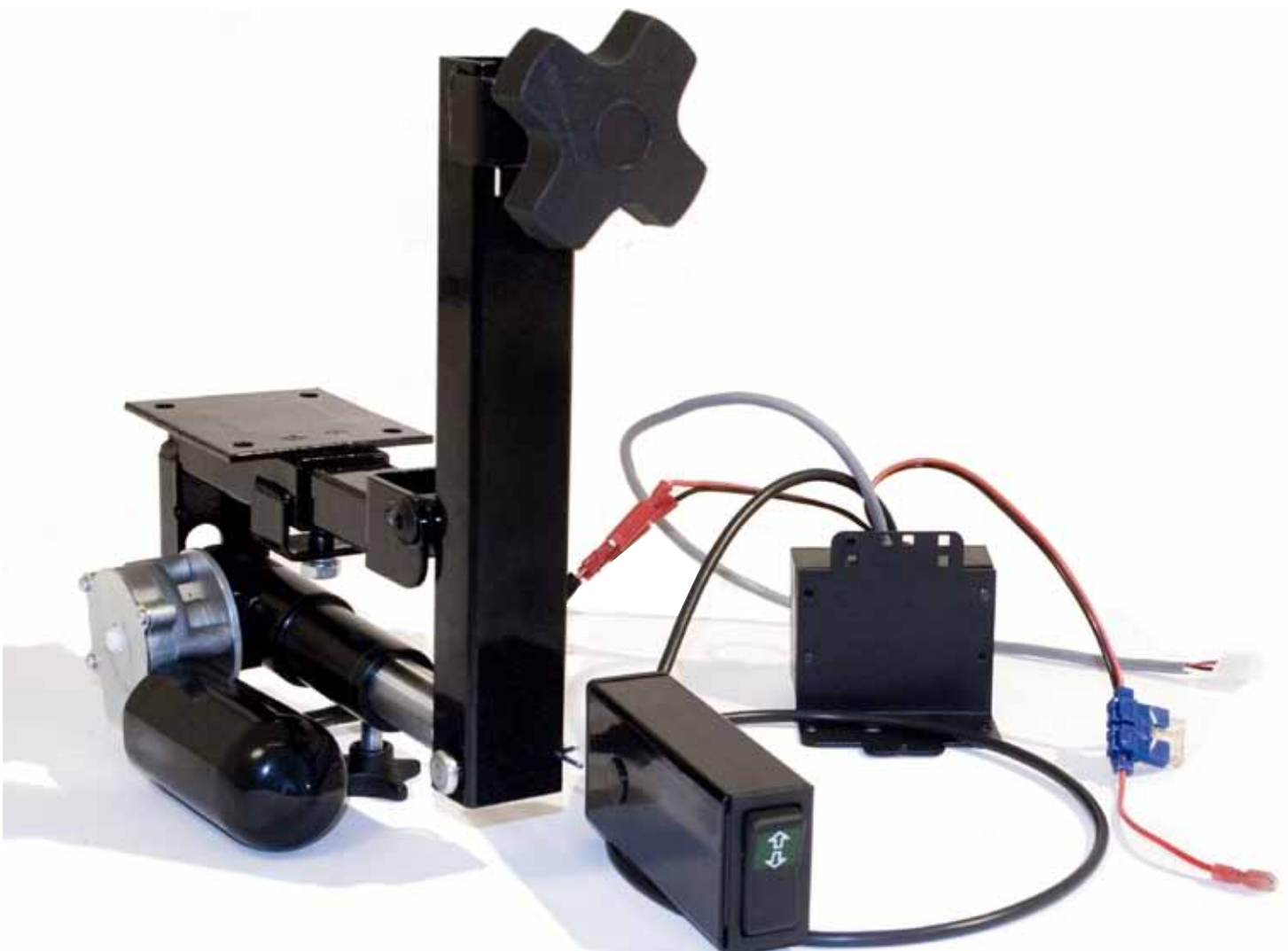



## TO COMPLETE A CHAIR WITH ELECTRIC BACK, WE RECOMMEND YOU TO ORDER THESE TWO KITS - **ART.NO 802726 & 802731**

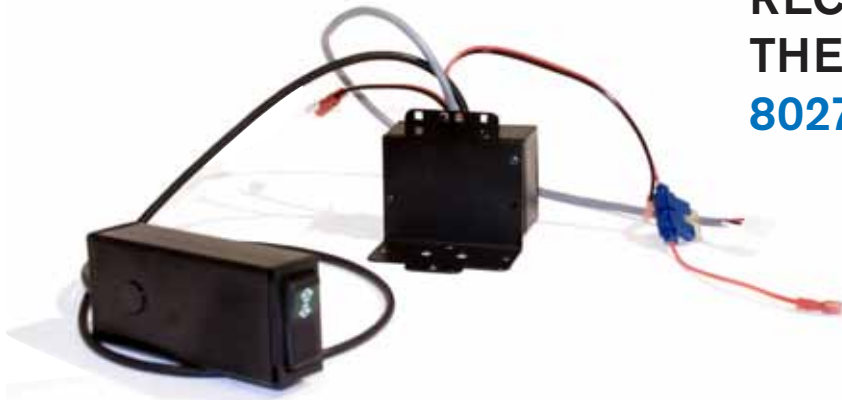

### ● CHARGE BOX MULTI STEP 1

To connect the [Charge box multi art.no 803030](#). Engage the contact marked **R** to the contact on the circuit board marked **K1**.



### ● MANEUVER BOX STEP 1

To connect the [Maneuver box art.no 802723](#). Engage the contact to the contact on the circuit board marked **K1**.



### ● CHARGE BOX ● MANEUVER BOX STEP 2

To connect the [Cabling for Motor art.no 802681](#). Engage the contact to the contact on the circuit board marked **K2**. The other end is to be connected to the engine.

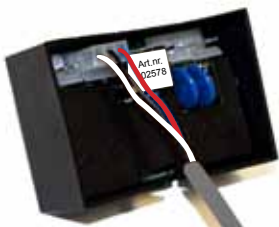

### ● CHARGE BOX ● MANEUVER BOX STEP 3

To connect the [Cabling for Electricity supply art.no 802718](#). Engage the contact to the contact on the circuit board marked **K3**. NOTE! The cable comes from the circuit board for Up & Down or prior circuit board.



### ● CHARGE BOX ● MANEUVER BOX STEP 4

To connect the [Cabling for Battery art.no 802648](#). Engage the contact to the contact on the circuit board marked **K4**. The other end is to be connected to the battery. BLACK cable connects to the negative pole of the battery. NOTE! RED cable connects to the positive pole of the battery. (If the chair is a multi, **K4** is used to supply electricity to the next circuit board).

# THE NEW ELECTRIC BRAKE FROM MERCADO

Since the new electronics are minuscontrolled they're not backwards compatible.

Electronics Version 1 can be combined with the electronics of Version 2.

Assembly instructions can be ordered separately from Mercado or be downloaded from [www.mercado.se](http://www.mercado.se)

The image indicates the appliances 802728 & 802732.

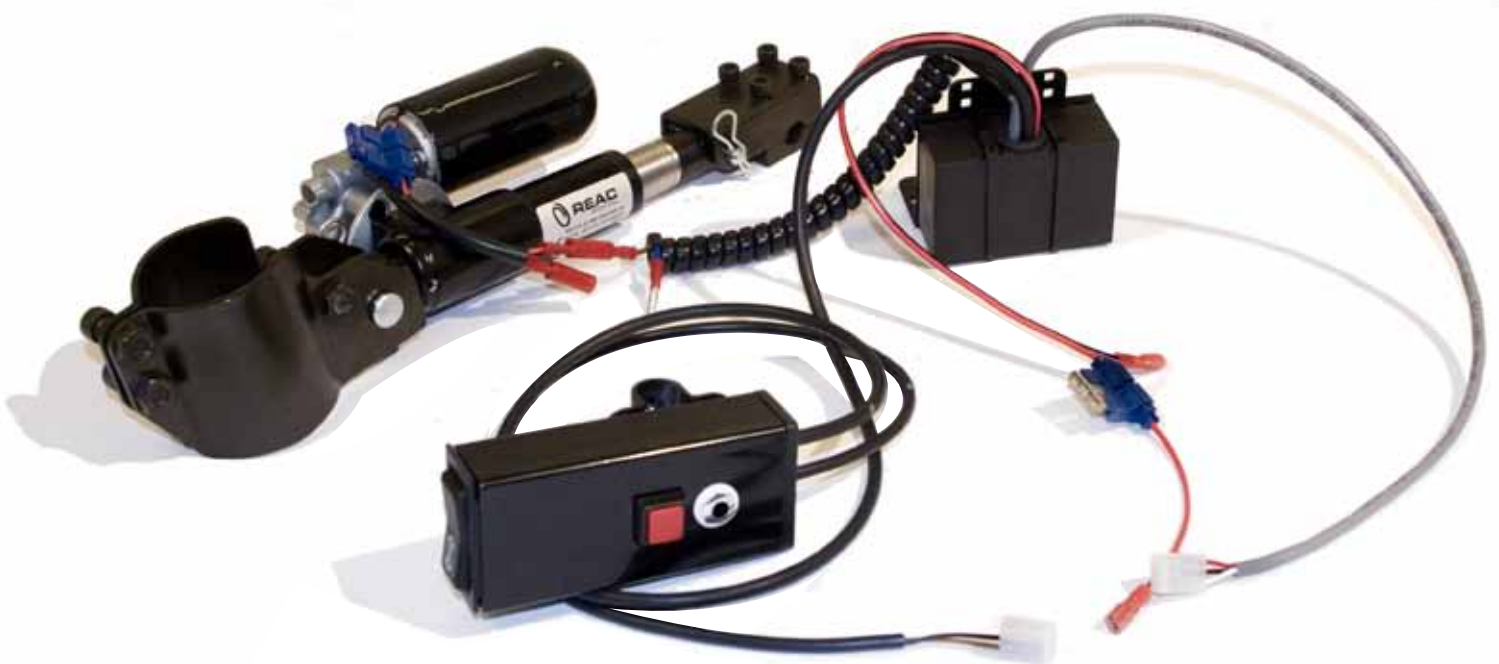

**TO COMPLETE A CHAIR WITH AN ELECTRIC BRAKE, WE RECOMMEND YOU TO ORDER THESE KITS - [ART.NO 802728](#) & [802732](#)**

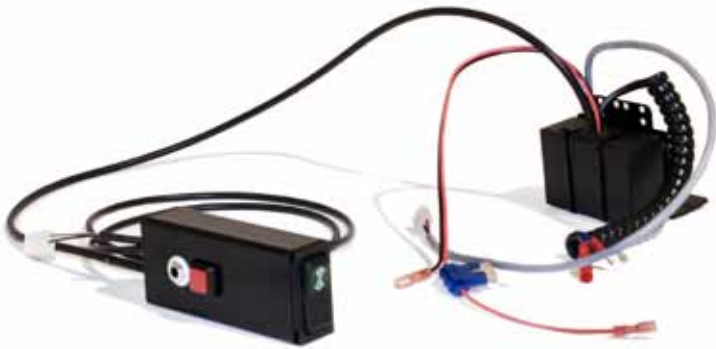

**CHARGE BOX MULTI STEP 1**

To connect the [Charge box multi art.no 803030](#). Engage the contact marked **B** to the contact on the circuit board marked **K1**.



**MANEUVER BOX STEP 1**

To connect the [Maneuver box with brake button art.no 803027](#) (replaces the maneuver box up/down 802721). Connect the cable with **ONE** contact to the contact on the circuit board marked **K1**. Connect the cable with **TWO** contacts to the relay card for up/down.



**CHARGE BOX MANEUVER BOX STEP 2**

To connect the [Cabling for Motor art.no 802719](#). Engage the contact to the contact on the circuit board marked **K2**. The other end is to be connected to the engine.

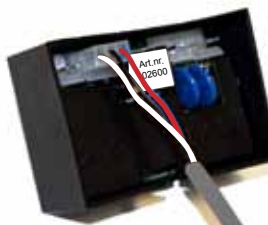

**CHARGE BOX MANEUVER BOX STEP 3**

To connect the [Cabling for Electricity supply art.no 802718](#). Engage the contact to the contact on the circuit board marked **K3**. NOTE! The cable comes from the circuit board for Up & Down or prior circuit board.



**CHARGE BOX MANEUVER BOX STEP 4**

To connect the [Cabling for Battery art.no 802648](#). Engage the contact to the contact on the circuit board marked **K4**. The other end is to be connected to the battery. **BLACK** cable connects to the negative pole of the battery. NOTE! **RED** cable connects to the positive pole of the battery. (If the chair is a multi, **K4** is used to supply electricity to the next circuit board).

# ARTICLE LISTING OVER APPLIANCES FOR MANEUVER BOX

## 802722 Relay card kit up/down+charg cpl incl. maneuver box 9000

Art.no	Term	Amount
803026	Maneuver box f up/down+charger cpl with cabling f Relay card	1 PCS
802681	Cabling f motor 9100 f Relay card	1 PCS
802648	Cabling f battery cpl 9100 f Relay card	1 PCS
803018	Cabling lead-through 10x14x1.5	1 PCS
802696	Maneuver button f Relay card	1 PCS
800774	Plastic plug Man box Electric chair 50x30	1 PCS
802546	Relay card current limitation Up-Down REAL9000	1 PCS
802832	Relay card box f Relay card	1 PCS
802835	Protective cover t Relay card box f Relay card	1 PCS
802833	Cover t Relay card box f Relay card	1 PCS
802834	Attachment t Relay card box f Relay card	1 PCS
800438	K6S M4x6 OBH Socket head cap screw M4x6 oval head screw	2 PCS
800023	Bundle strap 203x3.6mm black	2 PCS

## 802726 Relay card kit backrest angle cpl incl. maneuver box 9000

Art.no	Term	Amount
802723	Maneuver box f Seat /Backrest angle with cabling f Relay card	1 PCS
802681	Cabling f motor 9100 f Relay card	1 PCS
802718	Cabling f electricity supply f Relay card L=500mm	1 PCS
803019	Cable lead-through 11x14x1.5	1 PCS
802696	Maneuver button f Relay card	1 PCS
800774	Plastic plug Man box Electric chair 50x30	1 PCS
801070	Plastic stopper height adjust. arm -support	1 PCS
802578	Relay card current limitation Seat/Backangle 16 amp	1 PCS
802832	Relay card box f Relay card	1 PCS
802835	Protective cover t Relay card box f Relay card	1 PCS
802833	Cover t Relay card box f Relay card	1 PCS
802834	Attachment t Relay card box f Relay card	1 PCS
800438	K6S M4x6 OBH Socket head cap screw M4x6 oval head screw	2 PCS
802714	Bolster plate f Relay card	1 PCS
802862	MRT-TT FZB M4x6 (screw for charge box)	2 PCS
800023	Bundle strap 203x3.6mm black	4 PCS
800057	Bundle strap 71x1.8mm black	3 PCS

## 802731 Electric kit f backrest angle f relay card Real 9000

Art.no	Term	Amount
802644	Electric kit REAL f Backrest angle f Real 9000	1 PCS
801354	Cylindrical bolt fzb	2 PCS
801725	Clasp pin 2mm FZB Type B f Cylindrical bolt	2 PCS
801421	Electrical back attachment, adjustable Rear side	1 PCS
801422	Electrical back attachment, adjustable Front side	1 PCS
802744	Electrical back, back pipe lower f Electric kit	1 PCS
800837	Back tilting attachment Medic Cla/ErgoM	1 PCS
800369	M6S M8x16 8.8 FZB Screw M8x16 FZB	1 PCS
801212	Furniture Nut M6 Rough skull	2 PCS
800507	MPSH M6x38 FZB Pin screw M6x38	1 PCS
801566	MF6S M6x16 OBH 10.9 Socket sink head M6x16	2 PCS
800096	MC6S M6x16 FZB 8.8 Socket head cap screw M6x16 FZB	4 PCS
800462	BRB 6.4x12x1.5 black Plate 6.4x12x1.5 FZB	4 PCS

When needed; complete the electric kit with one of following back pillars:

801265	Back pillar Std. Cla/ErgoM Low back	1 PCS
800841	Back pillar Std. Cla/ErgoM High back	1 PCS

## 802724 Relay card kit seat angle cpl incl. maneuver box 9000

Art.no	Term	Amount
802723	Maneuver box f Seat /Backrest angle with cabling f Relay card	1 PCS
802681	Cabling f motor 9100 f Relay card	1 PCS
802718	Cabling f electricity supply f Relay card L=500mm	1 PCS
803019	Cable lead-through 11x14x1.5	1 PCS
802696	Maneuver button f Relay card	1 PCS
800774	Plastic plug Man box Electric chair 50x30	1 PCS
801070	Plastic stopper height adjust. arm -support	1 PCS
802578	Relay card current limitation Seat/Backangle 16 amp	1 PCS
802832	Relay card box f Relay card	1 PCS
802835	Protective cover t Relay card box f Relay card	1 PCS
802833	Cover t Relay card box f Relay card	1 PCS
802834	Attachment t Relay card box f Relay card	1 PCS
800438	K6S M4x6 OBH Socket head cap screw M4x6 oval head screw	2 PCS
802714	Bolster plate f Relay card	1 PCS
802862	MRT-TT FZB M4x6 (screw for charge box)	2 PCS
800023	Bundle strap 203x3.6mm black	4 PCS
800057	Bundle strap 71x1.8mm black	3 PCS

## 802730 Electric kit f seat angle f relay card Real 9000

Art.no	Term	Amount
802643	Electric kit REAL f seat angle f Real 9000	1 PCS
801354	Cylindrical bolt fzb	2 PCS
801725	Clasp pin 2mm FZB Type B f Cylindrical bolt	2 PCS

## 802728 Relay card kit brake cpl incl. maneuver box 9000

Art.no	Term	Amount
803027	Maneuver box f up/down+charger+brake kpl with cabling f Relay card	1 PCS
802719	Cabling f Electric kit Brake f Relay card (spiral cable)	1 PCS
802718	Cabling f electricity supply f Relaycard L=500mm	1 PCS
802642	Cabling f up/down and charging f Relaycard	1 PCS
803019	Cable lead-through 11x14x1.5	1 PCS
802696	Maneuver button f Relay card	1 PCS
800158	Pressure current adjuster IPC3SAD6 Brake button IP red square	1 PCS
800774	Plastic plug Man box Electric chair 50x30	1 PCS
802600	Relay card current limitation Brake 8 amp	1 PCS
802832	Relay card box f Relay card	1 PCS
802835	Protective cover t Relay card box f Relay card	1 PCS
802833	Cover t Relay card box f Relay card	1 PCS
802834	Attachment t Relay card box f Relay card	1 PCS
800438	K6S M4x6 OBH Socket head cap screw M4x6 oval head screw	2 PCS
802714	Bolster plate f Relay card	1 PCS
800436	SPAX KXTB 5x20 black-chrome black star squad. H-belt	2 PCS
800023	Bundle strap 203x3.6mm black	4 PCS
800057	Bundle strap 71x1.8mm black	3 PCS

## 802732 Electric kit f electric brake X/H-base Ø12 Axle

Art.no	Term	Amount
802645	Electric kit REAL f brake f Real 9000	1 PCS
802706	Electric brake Axle attachment Ø12mm f Electric kit	1 PCS
802707	Electric brake Centre attachment 9000 f Electric kit	1 PCS
801354	Cylindrical bolt fzb	2 PCS
801725	Clasp pin 2mm FZB Type B f Cylindrical bolt	2 PCS

# ARTICLE LISTING OVER APPLIANCES FOR CHARGE BOX

NOTE! Complete the appliances below with a charge box.

**803029 Charge box Hand Remote Joystick Up/down f relay card Ver 2**

**803030 Charge box Hand Remote Joystick Multi f relay card Ver 2**

**802748 Relay card kit up/down+ charg cpl excl. charge box**

Art.no	Term	Amount
802681	Cabling f motor 9100 f Relay card	1 PCS
802648	Cabling f battery cpl 9100 f Relay card	1 PCS
803018	Cabling lead-through 10x14x1.5	1 PCS
802546	Relay card current limitation Up-Dpwn/Seat angle 16 amp	1 PCS
802832	Relay card box f Relay card	1 PCS
802835	Protective cover t Relay card box f Relay card	1 PCS
802833	Cover t Relay card box f Relay card	1 PCS
802834	Attachment t Relay card box f Relay card	1 PCS
800438	K6S M4x6 OBH Socket head cap screw M4x6 oval head screw	2 PCS
800023	Bundle strap 203x3.6mm black	4 PCS

**802750 Relay card kit backrest angle cpl excl. charge box**

Art.no	Term	Amount
802681	Cabling f motor 9100 f Relay card	1 PCS
802718	Cabling f electricity supply f Relay card L=500mm	1 PCS
803019	Cabling lead-through 11x14x1.5	1 PCS
802578	Relay card current limitation Seat/Backrest angle 16 amp	1 PCS
802832	Relay card box f Relay card	1 PCS
802835	Protective cover t Relay card box f Relay card	1 PCS
802833	Cover t Relay card box f Relay card	1 PCS
802834	Attachment t Relay card box f Relay card	1 PCS
800438	K6S M4x6 OBH Socket head cap screw M4x6 oval head screw	2 PCS
802714	Bolster plate f Relay card	1 PCS
802862	MRT-TT FZB M4x6 (screw for charge box)	1 PCS
800023	Bundle strap 203x3.6mm black	4 PCS
800057	Bundle strap 71x1.8mm black	3 PCS

**802731 Electric kit f backrest angle f relay card Real 9000**

Art.no	Term	Amount
802644	Electric kit REAL f backrest angle f Real 9000	1 PCS
801354	Cylindrical bolt fzb	2 PCS
801725	Clasp pin 2mm FZB Type B f Cylindrical bolt	2 PCS
801421	Electric back attachment, adjustable Rear side	1 PCS
801422	Electric back attachment, adjustable Front side	1 PCS
802744	Electric back, back pipe lower f Electric kit	1 PCS
800837	Back tilting attachment Medic Cla/ErgoM	1 PCS
800369	M6S M8x16 8.8 FZB Screw M8x16 FZB	1 PCS
801212	Furniture Nut M6 Rough skull	2 PCS
800507	MPSH M6x38 FZB Pin screw M6x38	1 PCS
801566	MF6S M6x16 OBH 10.9 Socket sink head M6x16	2 PCS
800096	MC6S M6x16 FZB 8.8 Socket head cap screw M6x16 FZB	4 PCS
800462	BRB 6.4x12x1.5 black Plate 6.4x12x1.5 FZB	4 PCS

When needed; complete the electric kit with one of following back pillar:

801265	Back pillar Std. Cla/ErgoM Low back	1 PCS
800841	Back pillar Std. Cla/ErgoM High back	1 PCS

## 802749 Relay card kit seat angle cpl excl. charge box

Art.nr	Benämning	Antal
802681	Cabling f motor 9100 f Relay card	1 PCS
802718	Cabling f electricity supply f Relay card L=500mm	1 PCS
803019	Cabling lead-through 11x14x1.5	1 PCS
802578	Relay card current limitation Seat/Backrest angle 16 amp	1 PCS
802832	Relay card box f Relay card	1 PCS
802835	Protective cover t Relay card box f Relay card	1 PCS
802833	Cover t Relay card box f Relay card	1 PCS
802834	Attachment t Relay card box f Relay card	1 PCS
800438	K6S M4x6 OBH Socket head cap screw M4x6 oval head screw	2 PCS
802714	Bolster plate f Relay card	1 PCS
802862	MRT-TT FZB M4x6 (screw for charge box)	1 PCS
800023	Bundle strap 203x3.6mm black	4 PCS
800057	Bundle strap 71x1.8mm black	3 PCS

## 802730 Electric kit f seat angle f relay card Real 9000

Art.no	Term	Amount
802643	Electric REAL f seat angle f Real 9000	1 PCS
801354	Cylindrical bolt fzb	2 PCS
801725	Clasp pin 2mm FZB Type B f Cylindrical bolt	2 PCS

## 802751 Relay card kit brake cpl excl. charge box

Art.nr	Benämning	Antal
802719	Cabling f Electric kit Brake f Relay card (spiral cable)	1 PCS
802718	Cabling f electricity supply f Relay card L=500mm	1 PCS
803019	Cabling lead-through 11x14x1.5	1 PCS
802600	Relay card current limitation Brake 8 amp	1 PCS
802832	Relay card box f Relay card	1 PCS
802835	Protective cover t Relay card box f Relay card	1 PCS
802833	Cover t Relay card box f Relay card	1 PCS
802834	Attachment t Relay card box f Relay card	1 PCS
800438	K6S M4x6 OBH Socket head cap screw M4x6 oval head screw	2 PCS
802714	Bolster plate f Relay card	1 PCS
800436	SPAX KXTB 5x20 black-chrome black star squad. H-belt	1 PCS
800023	Bundle strap 203x3.6mm black	4 PCS
800057	Bundle strap 71x1.8mm black	3 PCS

## 802732 Electric kit f electric brake X/H-base Ø12 Axle

Art.no	Term	Amount
802645	Electric kit REAL f brake f Real 9000	1 PCS
802706	Electric brake Axle attachment Ø12mm f Electric kit	1 PCS
802707	Electric brake Centre attachment 9000 f Electric kit	1 PCS
801354	Cylindrical bolt fzb	2 PCS
801725	Clasp pin 2mm FZB Type B f Cylindrical bolt	2 PCS

# ARTICLE LISTING OVER APPLIANCES FOR CHARGE BOX

1



2



3



4



5



6



7



8



9



10



## CHARGEBOX DETAILS

	Art.No
1 Hand control Up/Down	802739
2 Hand control Multi	802740
3 Remote control, Transmitter Up/Down	801806
4 Remote control, Transmitter Multi	801808
5 Remote control, Kit Up/Down	802686
6 Remote control, Reciever Up/Down	802737
7 Remote control, Reciever Multi	802738
8 Remote control, Kit Multi	802687
9 Foot control electric lever	802688
10 Joystick 3 func. + brake	802743
Joystick 2 func. + brake	802742
Joystick 2 func. no brake	802741